

PowerLink

Assembly Guide

PB-200-XX

36", 48", 60", 72" Widths



9	POWER POLE	POWER POLE
8	ENTER WIRE MANAGEMENT	ENTER WIRE MANAGEMENT
7	SINGLE LEG	TOP CAP WITH A HOLE
6	SINGLE LEG	ONE SHORT SIDE COVER
5	MOUNTING BOLTS	MOUNTING BOLTS
4	BEAM	BEAM
3	FESTOON CABLE	FESTOON CABLE
2	POWER CABLE	POWER CABLE
1	SINGLE LEG	TWO SHORT SIDE COVER
	PART ITEM	DESC

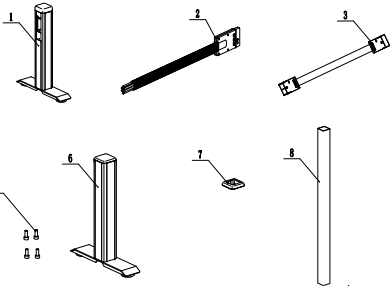

1

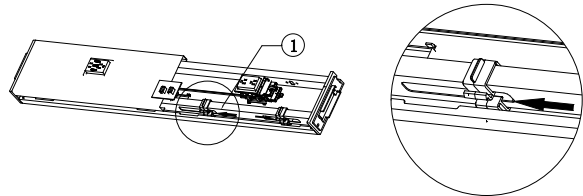

① Move bottom plastic support aside to make it easier to remove the metal tile

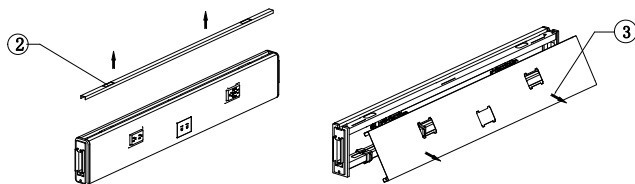

③ Remove the top cover strip
② Remove the metal tile

3

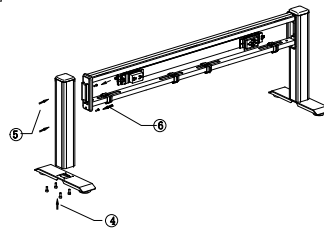

④ Assembly the bottom feet and leg together with stainless bolts.
⑤ Hook the finished fram to the connectors
⑥ Tighten the fram and connectors with stainless bolts

⑦ Slide bottom plastic support into the grooved side at the bottom of the panel
⑧ Insert the bump on the top of the panel into the groove of the beam, and slide bottom plastic support to secure the metal tile.
⑨ Insert the top cover strip

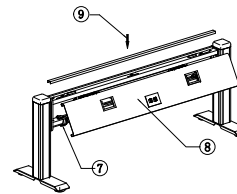

4

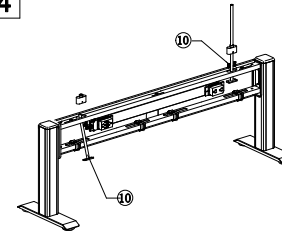

⑩ Pass the screen pole through the upper beam hole and secure it with installation screws.

① Slide bottom plastic support into the grooved side at the bottom of the panel
② Insert the bump on the top of the panel into the groove of the beam, and slide bottom plastic support to secure the metal tile.
③ Insert the screen into the bottom hole of the screen pole.

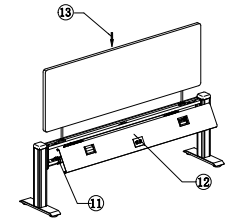

5

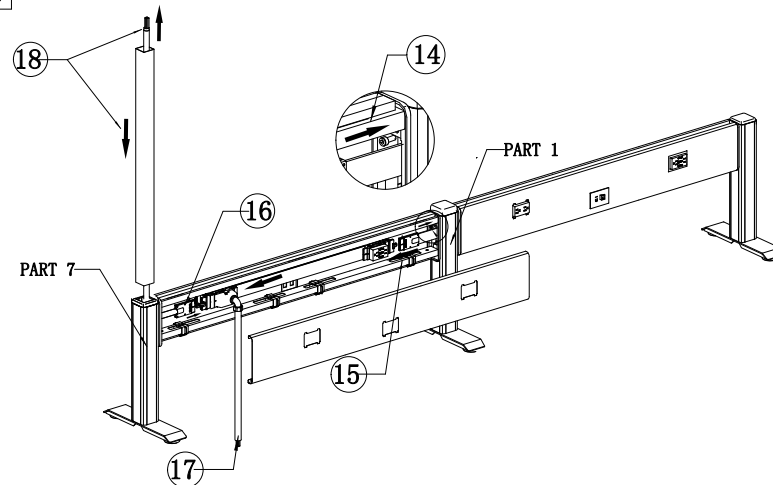

④ Tighten the fram and connectors with stainless bolts
⑤ Insert festoon cable into power hardness
⑥ Insert power entry cable into power hardness
⑦ remove the socket and attach the grounding wire. Thread the end of the grounding wire through the side panel hole and cover the side panel.
⑧ Insert power pole and Pass the power cord through the power pole
Two different power connection methods, choose according to your needs

